

# USER MANUAL

## **HTR02 series**

Heaters for verification of performance of  
FHF-series heat flux sensors



# Warning statements

Cautionary statements are subdivided into four categories: danger, warning, caution and notice according to the severity of the risk.

 <b>DANGER</b>
<b>Failure to comply with a danger statement will lead to death or serious physical injuries.</b>

 <b>WARNING</b>
<b>Failure to comply with a warning statement may lead to risk of death or serious physical injuries.</b>

 <b>CAUTION</b>
<b>Failure to comply with a caution statement may lead to risk of minor or moderate physical injuries.</b>

<b>NOTICE</b>
<b>Failure to comply with a notice may lead to damage to equipment or may compromise reliable operation of the instrument.</b>

# Contents

<b>Warning statements</b>	<b>2</b>
<b>Contents</b>	<b>3</b>
<b>List of symbols</b>	<b>4</b>
<b>Introduction</b>	<b>5</b>
<b>1 Ordering and checking at delivery</b>	<b>7</b>
1.1 Ordering HTR02	7
1.2 Included items	7
1.3 Quick instrument check	8
<b>2 Instrument principle and theory</b>	<b>9</b>
2.1 Basic operation	9
2.2 A self-test for heat flux sensors	9
2.3 Using heaters with FHF heat flux sensors	10
2.4 Validation of heat flux sensors	12
2.5 An in-situ test for heat flux sensors	13
<b>3 Specifications of HTR02 heaters</b>	<b>17</b>
3.1 Specifications of HTR02 heaters	17
3.2 Dimensions of HTR02 series	19
<b>4 Installation of HTR02 series</b>	<b>20</b>
4.1 Site selection and installation	20
4.2 Electrical connection	22
4.3 Requirements for data acquisition and control	25
<b>5 Maintenance and trouble shooting</b>	<b>26</b>
5.1 Recommended maintenance and quality assurance	26
5.2 Trouble shooting	27
<b>6 Appendices</b>	<b>29</b>
6.1 EU declaration of conformity	29

# List of symbols

## Quantities

	<b>Symbol</b>	<b>Unit</b>
Heat flux	$\Phi$	W/m <sup>2</sup>
Voltage	U	V
Sensitivity	S	V/(W/m <sup>2</sup> )
Temperature	T	°C
Thermal resistance per unit area	R <sub>thermal,A</sub>	K/(W/m <sup>2</sup> )
Area	A	m <sup>2</sup>
Electrical resistance	R	Ω
Electrical power	P	W

## Subscripts

Property of heatsink	heatsink
Property of heater	heater
Property of sensor	sensor
Maximum value, specification limit	maximum

# Introduction

HTR02 heaters are so-called foil heaters. They can be used for functionality checks of foil heat flux sensors like those of the **FHF05 series**. The heaters have a 4-wire connection with a known surface area and electrical resistance. Users can now easily and objectively check their sensor performance before and after use. HTR02 series is available in two different models: 50 x 50 and 85 x 85 mm. See also **FHF05SC series** heat flux sensor with integrated heater.

Measuring heat flux, users may wish to regularly check their sensor performance. A quick check is now possible with HTR02 heaters plus some accessories that most laboratories will have in-house. The HTR02 heaters have a well-characterised traceable surface area and electrical resistance.

In a typical test setup, the heat losses through the insulation are typically smaller than 3 % and may be ignored. Measuring the heater power (voltage  $U_{\text{heater}}$  square divided by resistance  $R_{\text{heater}}$ ), and dividing by the surface area  $A_{\text{heater}}$ , gives the applied heat flux. The heat flux sensor sensitivity  $S$  is the voltage output  $U_{\text{sensor}}$  divided by the applied heat flux.

$$S = (U_{\text{sensor}} \cdot R_{\text{heater}} \cdot A_{\text{heater}}) / U_{\text{heater}}^2 \quad (\text{Formula 0.1})$$

The reproducibility of this test is much improved when using contact material between the heater, sensor and heat sink.

HTR02 series has unique features and benefits:

- makes it possible to perform a simple test
- guarantees sensor stability
- matches all models of the FHF05 series heat flux sensors

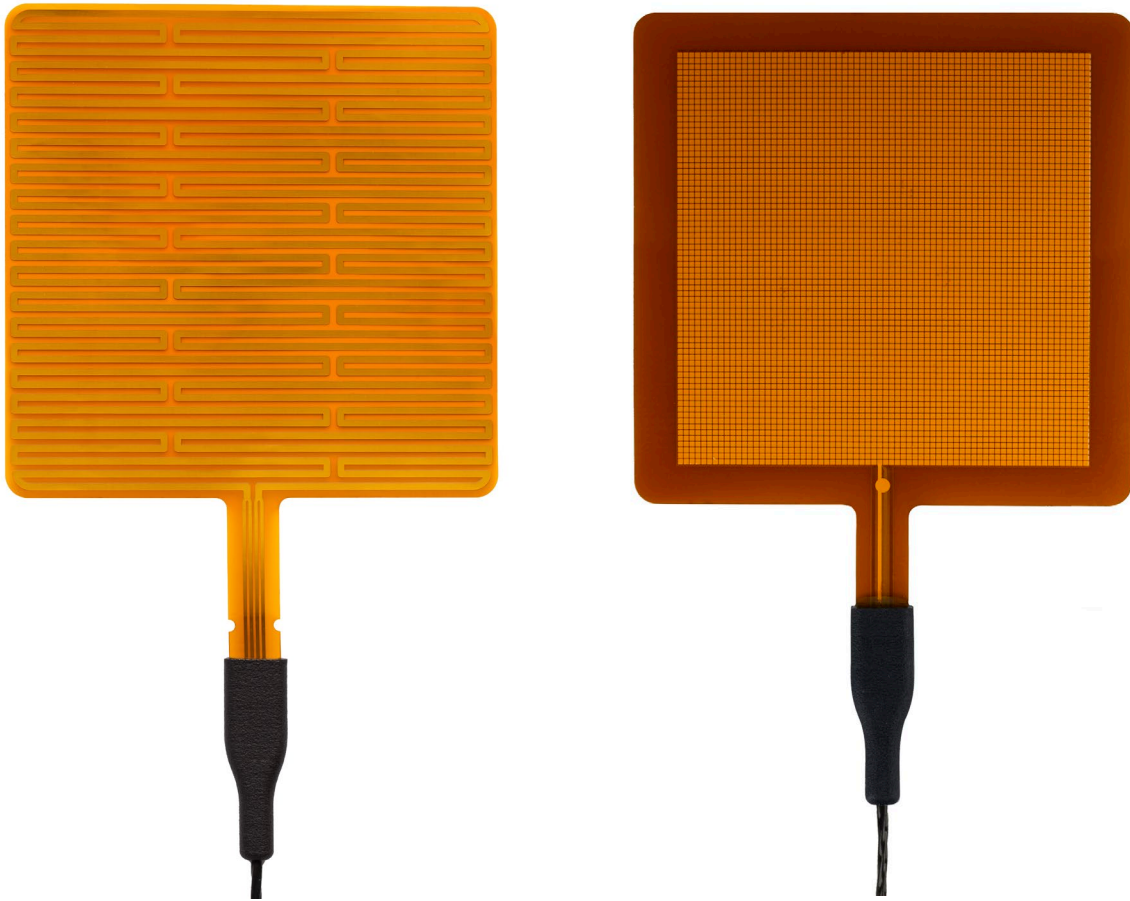

**Figure 0.1** On the left: model HTR02-85X85 heater for calibration and verification of performance of the models of FHF05 series heat flux sensors. On the right: model HF05-85X85 to which HTR02-85X85 may be applied. See also Figure 3.2.1 for dimensions.

HTR02 comes in two models. These can be used for test purposes in combination with foil heat flux sensors, such as those of the FHF05 series, or as general-purpose heaters.

Options:

- available with standard cable length -02 metre, or change -02 to -05 or -10 metres for the respective cable length
- cables can also be ordered separately in 2, 5 or 10 metres length

See also:

- [FHF05SC](#) heat flux sensor with integrated heater
- [FHF05 series](#) general purpose heat flux sensor
- view our complete range of [heat flux sensors](#)

# 1 Ordering and checking at delivery

## 1.1 Ordering HTR02

The standard configuration of HTR02 series is model 50X50 with 2 metres of cable, order code: HTR02-50X50-02.

Common options are:

- model HTR02-85X85
- -05 or -10 metres cable length
- with a separate cable in 2, 5 or 10 metres cable length

## 1.2 Included items

Arriving at the customer, the delivery should include:

- HTR02 heater with cable of the length as ordered
- product certificate matching the instrument serial number



**Figure 1.2.1** Model HTR02-50X50 with serial number and resistance shown at the end of the cable.

### 1.3 Quick instrument check



#### CAUTION

**Do not put a voltage of more than 0.1 V over 2 wires that connect to the same side of the heater: the two yellow wires on one side of the heater, or the two grey wires on the other side of the heater.  
The traces on the heater foil may overheat and get damaged beyond repair.**

A quick test of the heater can be done by connecting it to a multimeter:

1. Check the heater serial number on the label at the end of HTR02's cable against the product certificate provided with the heater.
2. Inspect the instrument for any damage.
3. Check the electrical resistance of the heater between any of the yellow wires and any of the grey wires. Use a multimeter at the 1 k $\Omega$  range. Typical resistance should be around 120  $\Omega$  for model -50X50 and around 40  $\Omega$  for model -85X85. Infinite resistance indicates a broken circuit; zero or a lower than 1  $\Omega$  resistance indicates a short circuit.
4. Check the electrical resistance between the 2 yellow wires. These resistances should be in the 0.1  $\Omega$ /m range, so 0.2  $\Omega$  in case of the standard 2 m wire length. Higher resistances indicate a broken circuit. Repeat this measurement for the 2 grey wires.



## 2 Instrument principle and theory

HTR02 series is a foil heater. It can either be used in combination with foil heat flux sensors such as FHF05 series for test and calibration purposes, or it can be used as a general-purpose heater.

### 2.1 Basic operation

If a voltage  $U_{\text{heater}}$  is applied to the heater such that an electrical current  $I_{\text{heater}}$  runs through the heater, the heater power  $P_{\text{heater}}$  may be calculated as:

$$P_{\text{heater}} = U_{\text{heater}} \cdot I_{\text{heater}} = U_{\text{heater}}^2 / R_{\text{heater}} = I_{\text{heater}}^2 \cdot R_{\text{heater}}$$

where  $R_{\text{heater}}$  is the heater electrical resistance. If the heater is placed in a uniform environment (i.e., same medium on both sides of the heater) the applied heat flux  $\Phi$  in either direction may be calculated as:

$$\Phi = P_{\text{heater}} / (2 \cdot A_{\text{heater}}) \quad (\text{Formula 2.1.1})$$

where  $A_{\text{heater}}$  is the heater area. If, however, the heater is placed in between a thermal insulator and a good thermal conductor the heat flux  $\Phi$  in the direction of the conductor is:

$$\Phi = P_{\text{heater}} / A_{\text{heater}} \quad (\text{Formula 2.1.2})$$

Other cases exist as well. Users need to evaluate which case applies to their situation.

### 2.2 A self-test for heat flux sensors

In combination with a heat flux sensor such as FHF05 series, HTR02 can be used to test the response of the heat flux sensor. To this end, HTR02 should be positioned directly on top of the heat flux sensor so that HTR02 can be used to apply a heat flux through the heat flux sensor.

A self-test is started by switching on HTR02, while recording the heat flux sensor output signal and the HTR02 heater power and finalised by switching HTR02 off. During the heating interval, a current  $I_{\text{heater}}$  is fed through the foil heater which generates a known heat flux proportional to the heater power. To calculate this heat flux, the heater power  $P_{\text{heater}}$  must be measured accurately. This power can be measured in several different ways;

- heater voltage and current,  $P_{\text{heater}} = U_{\text{heater}} \cdot I_{\text{heater}}$  (Formula 2.2.1)
- heater voltage and known heater resistance,  $P_{\text{heater}} = U_{\text{heater}}^2 / R_{\text{heater}}$  (Formula 2.2.2)
- heater current and known heater resistance,  $P_{\text{heater}} = I_{\text{heater}}^2 \cdot R_{\text{heater}}$  (Formula 2.2.3)

If performed in a four-wire configuration, the first method of formula 2.2.1 is preferred, because it is generally more accurate than the latter two methods. However, it requires both a voltmeter and an ammeter instead of just one of the two. This is why the method of formula 2.2.2 is more commonly applied.

Analysis of the heat flux sensor response to the heating (the self-test) serves several purposes:

- first, the amplitude and response time under comparable conditions are indicators of the sensor stability. See 2.5 for application examples.
- second, the functionality of the complete measuring system is verified. For example: a broken cable is immediately detected.
- third, under the right conditions, after taking the sensor out of its normal environment, the self-test may be used as calibration. See 2.4 for more details.

### 2.3 Using heaters with FHF heat flux sensors

HTR02 series is compatible with the models from the FHF05 series. Model FHF05-50X50 and -85X85 fit directly with HTR02-50X50 and -85X85 respectively.

Models FHF05-10X10 and FHF05-15X30 fit with HTR02-50X50. Model FHF05-15X85 can be used with HTR02-85X85. Because in these cases the heater is larger than the sensor, it is recommended to make a guard when using these models with HTR02. See Table 2.3.1 for an overview of the models and suggested heaters.

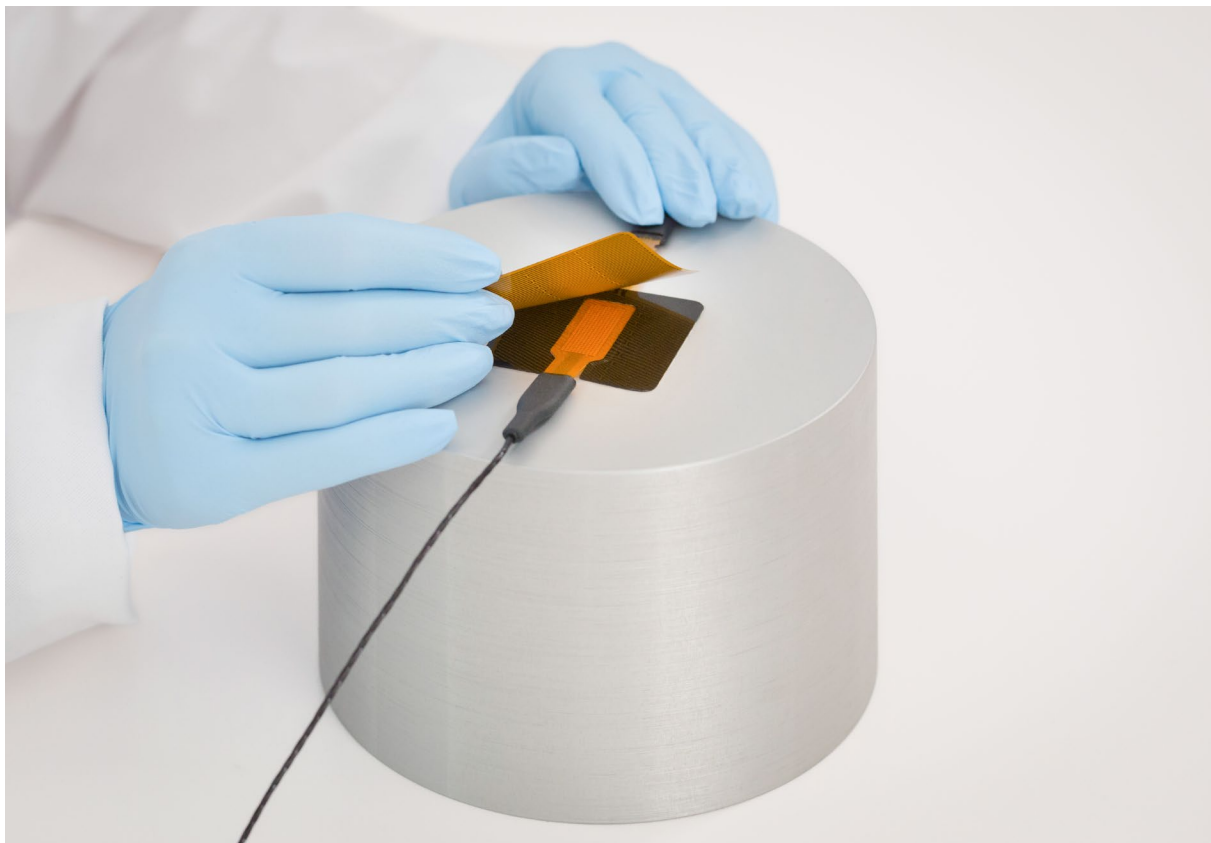

**Figure 2.3.1** Using heater model HTR02-50X50 with heat flux sensor FHF05-15X30. A plastic guard around the sensor is made with the help of a 3D-printer.

To get a representative measurement, the heater should 'see' the same environment. Surrounded by a material like a metal heat sink, the sensor will locally increase the thermal resistance. The heat from the heater will follow the easiest path; in the case the heater is larger than the sensor, flow to the metal heat sink. Therefore, the sensor will measure an underestimation of the actual heat flux.

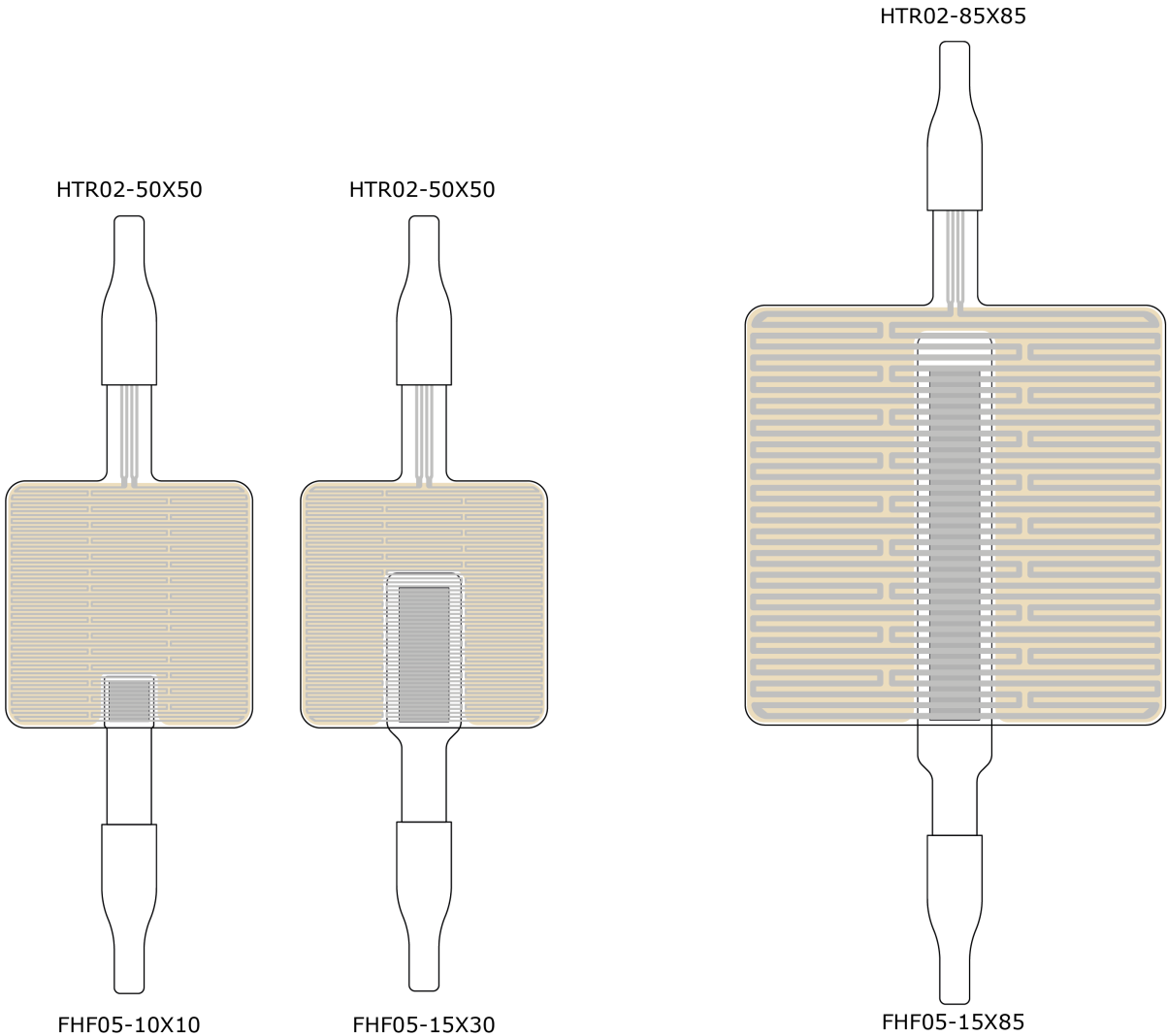

**Figure 2.3.2** Using HTR02 series heaters with FHF05 series. FHF05 models -10X10 and -15X30 are compatible with HTR02-50X50. Model FHF05-15X85 is compatible with HTR02-85X85. We recommend making a guard around the sensor with equal thermal resistance and thickness. The orange-coloured part is the area where we recommend making a guard.

To create an environment with constant thermal resistance, make a guard around the sensor with equal thermal resistance and thickness. FHF05 series have a thermal resistance of  $R_{\text{thermal}} = 11 \times 10^{-4} \text{ K}/(\text{W}/\text{m}^2)$  and a thickness of  $0.4 \times 10^{-3} \text{ m}$ .

We recommend a guard made from plastic. Most plastics have a thermal resistance in the same order of magnitude as the base material of the sensor. Use tape of comparable thickness or print a guard with a 3D printer. See Figure 2.3.1.

**Table 2.3.1** *Suggested use of FHF05 series with HTR02 series.*

<b>MODEL FHF05</b>	<b>SUGGESTED HTR02 MODEL</b>	<b>GUARD RECOMMENDED?</b>
FHF05-10X10	HTR02-50X50	yes
FHF05-15X30	HTR02-50X50	yes
FHF05-50X50	HTR02-50X50	no
FHF05-15X85	HTR02-85X85	yes
FHF05-85X85	HTR02-85X85	no

## 2.4 Validation of heat flux sensors

It is recommended to recalibrate heat flux sensors at least once every two years. HTR02 series can be used to validate the performance of heat flux sensors such as the models in the FHF05 series.

In a typical calibration setup, as shown in Figure 2.4.1, a stack is made of a heatsink, the heat flux sensor to be validated, the heater and an insulating material. In such a setup, the heat losses through the insulation are for FHF-type sensors in the order of magnitude of 3 %. In this case, heat generated by HTR02 flows through the heat flux sensor to the heat sink. Measuring the heater power  $P_{\text{heater}}$ , and dividing by the surface area  $A_{\text{heater}}$ , gives the applied heat flux:

$$\Phi = P_{\text{heater}}/A_{\text{heater}} \quad (\text{Formula 2.4.1})$$

The heat flux sensor sensitivity  $S$  is the voltage output of the sensor  $U_{\text{sensor}}$  divided by the applied heat flux  $\Phi$ :

$$S = U_{\text{sensor}}/\Phi \quad (\text{Formula 2.4.2})$$

The reproducibility of this test is much improved when using contact material (such as glycerol or a thermal paste) between heater, sensor and heat sink.

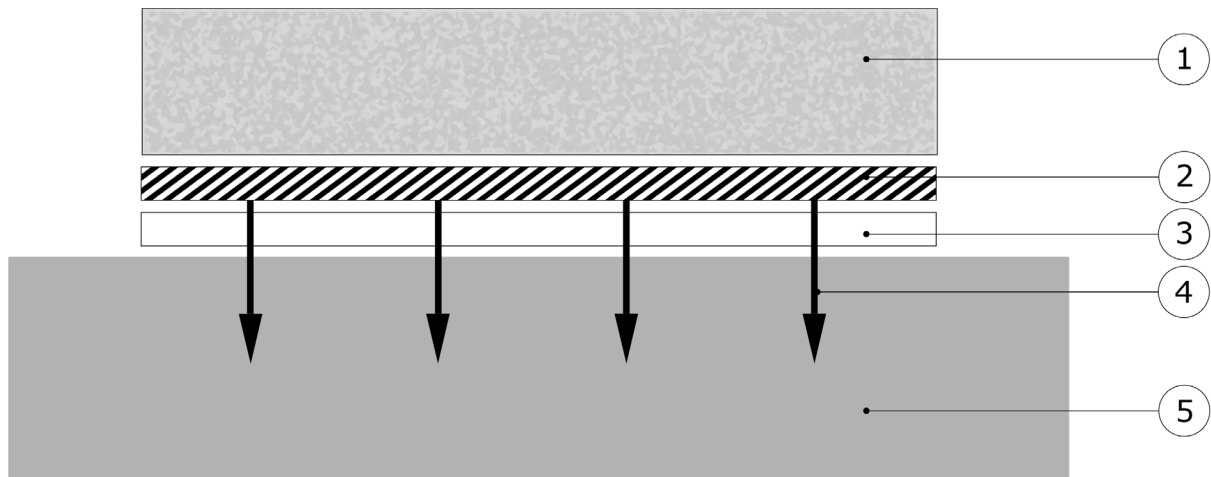

**Figure 2.4.1** Performance validation of a heat flux sensor; a typical stack used for calibration consists of a block of metal (mass > 1 kg), for example aluminium (5), the heat flux sensor (3), HTR02 (2) and an insulation foam (1). Under these conditions, heat losses through the insulation are negligible. Heat flux (4) flows from hot to cold.

## 2.5 An in-situ test for heat flux sensors

The HTR02 series heater can be used to test the stable performance of the heat flux sensors such as FHF05 series.

HTR02 series should be installed on top of the heat flux sensor, preferably on the side of the heat flux sensors with the more insulating medium. In case the heater is used for repeated verifications at one location, consider using our FHF05SC series: sensor with a HTR02 heater integrated.

A typical stability check is performed based on the step response of the measured heat flux and sensor temperature to a heat flux applied by HTR02. Upon installing the heat flux sensor and HTR02, a reference measurement should be made. A time trace of the heater power, the measured heat flux and the measured sensor temperature should be stored as reference data. Stable operation of the heat flux sensor can then be confirmed at any time by comparing it to the reference measurement. The test protocol consists of the following steps:

1. Make sure that the absolute temperature is similar to that during the reference measurement.
2. Check the heater resistance stability. This can be done accurately by using the four heater wires to conduct a four-point resistance measurement.
3. Record a time trace of the heater power, the measured heat flux and the sensor temperature; the same parameters as in the reference data. Normalise the data by the heater power. Under normal circumstances (if the heater is stable) this process scales with  $U_{\text{heater}}^2$ .
4. Compare patterns of heat flux and temperature rise and fall. In both cases relative to the values just before heating. When the signal patterns match, amplitude differences, after correction for heater power, point towards sensor instability. In this case, recalibration of the sensor may be required (Figure 2.5.1). Non-matching patterns point towards changes in the sensor environment. This can, for example, be the result of a loss of thermal contact between sensor and object (Figure 2.5.2) or the presence of convective heat losses (Figure 2.5.3).

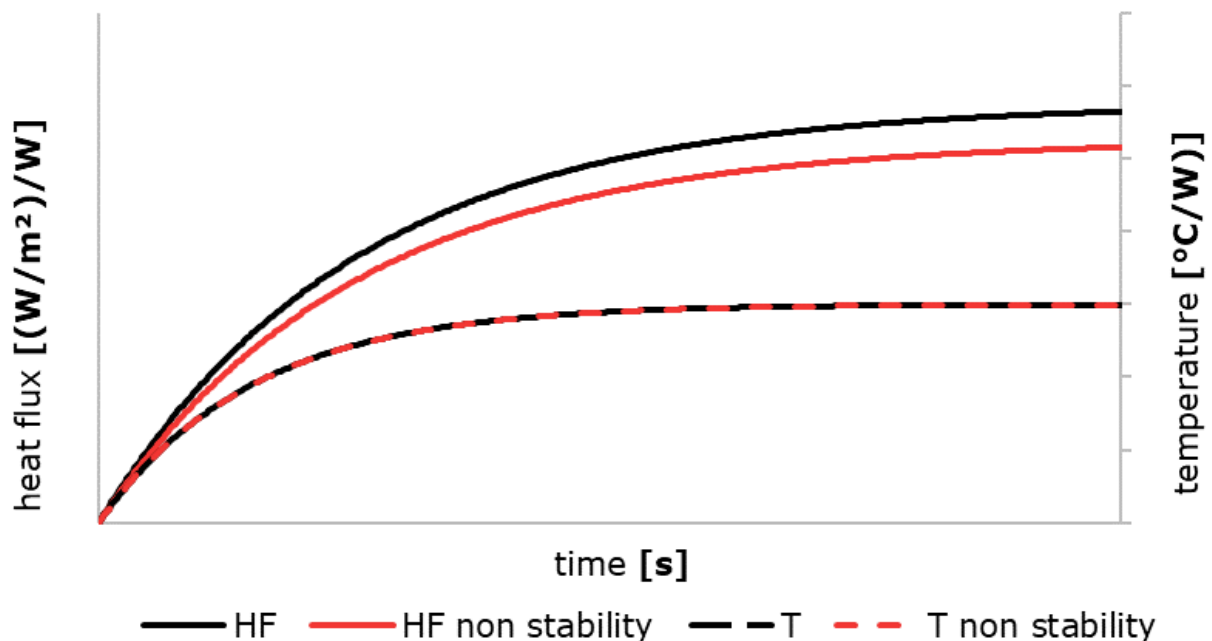

**Figure 2.5.1** *In-situ sensor stability check. Comparison of responses to stepwise heating relative to reference curves. Normalised to heater power ( $P$ ) and relative to the heat flux and the temperature just before heating. Solid graphs show heat flux, dotted graphs show temperature. The black HF and T signals are the reference curves at installation. The sensor shows non-stability, loses sensitivity over time, which results in the red responses: equal response times, lower heat flux and equal temperature rise.*

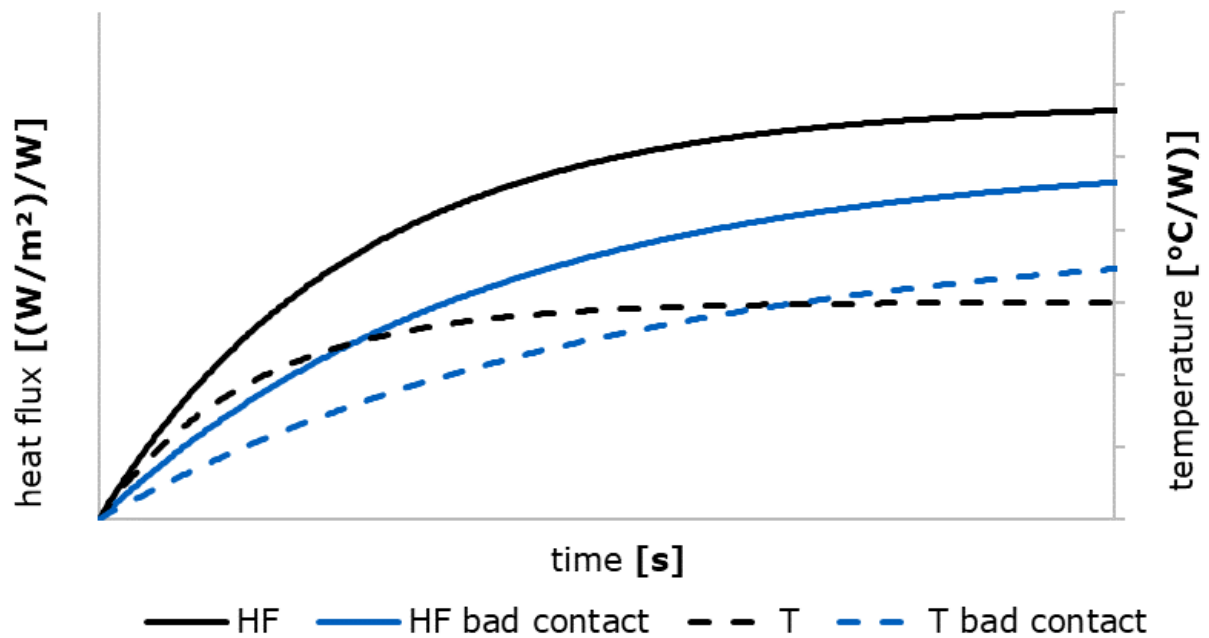

**Figure 2.5.2** *In-situ sensor stability check. Comparison of responses to stepwise heating relative to reference curves. Normalised to heater power (P) and relative to the heat flux and the temperature just before heating. Solid graphs show heat flux, dotted graphs show temperature. The black HF and T signals are the reference curves at good thermal contact. The sensor loses thermal contact, which results in the blue responses: slower response times, lower heat flux and higher temperature rise.*

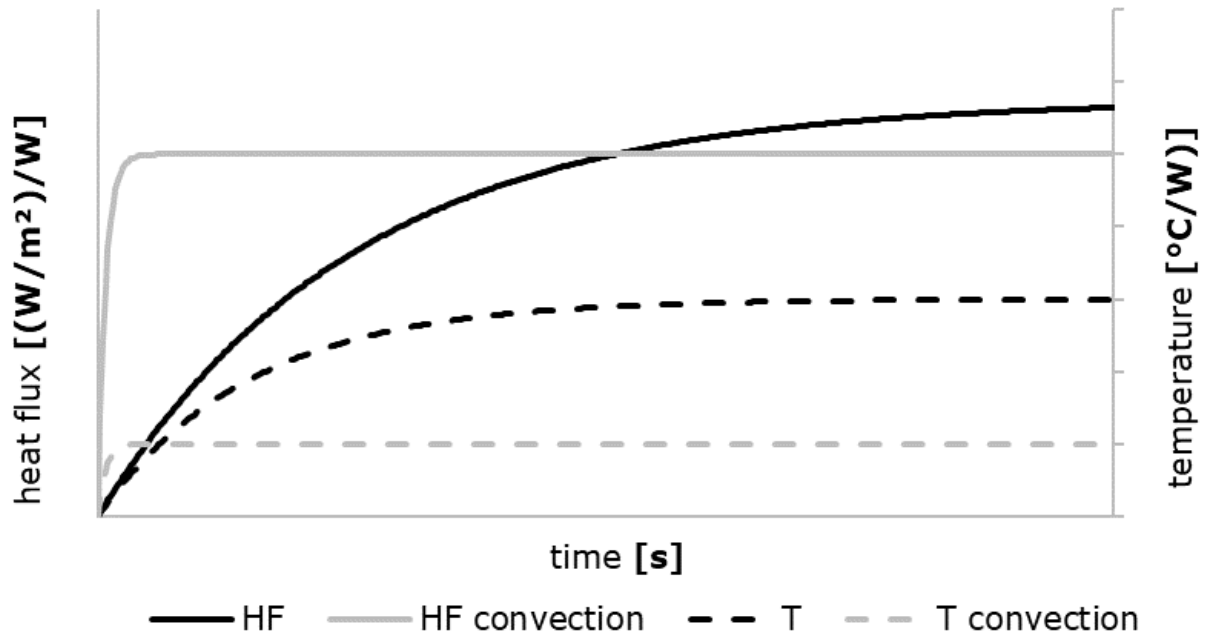

**Figure 2.5.3** *In-situ sensor stability check. Comparison of responses to stepwise heating relative to reference curves. Normalised to heater power (P) and relative to the heat flux and the temperature just before heating. Solid graphs show heat flux, dotted graphs show temperature. The black HF and T signals are the reference curves at zero wind speed. The sensor is exposed to convection, which results in the grey responses: faster response times at lower heat flux and lower temperature rise.*



## 3 Specifications of HTR02 heaters

### 3.1 Specifications of HTR02 heaters

Heaters of the HTR02 are thin, flexible foil heaters with 4-wire connection, a known surface area and a known electrical resistance. They are designed for validation and functionality checks of FHF-type heat flux sensors, but can also be used for general heating purposes. When used to test heat flux sensors, HTR02's must be combined with a switched or controlled power supply and a suitable measurement and control system.

**Table 3.1** Specifications of HTR02 series (continued next page).

<b>HTR02 SERIES SPECIFICATIONS</b>	
Product type	foil heater
Measurement function / required programming	depends on the application
Required readout	1 x current channel and 1 x voltage channel, alternatively 1 x current channel alternatively 1 voltage channel. currents may be measured using a voltage channel which acts as a current measurement channel using a current sensing resistor, heater: 1 x switchable 12 VDC
Rated load on the cable	$\leq 1.6$ kg
Rated bending radius	$\geq 7.5 \times 10^{-3}$ m
Operating temperature range	-40 to +150 °C
Heater length and width per dimension	
HTR02-50X50	$(48 \times 47.6) \times 10^{-3}$ m
HTR02-85X85	$(83 \times 82.6) \times 10^{-3}$ m
Heater area	
HTR02-50X50	$2381 \times 10^{-6}$ m <sup>2</sup>
HTR02-85X85	$7022 \times 10^{-6}$ m <sup>2</sup>
Passive guard area	
HTR02-50X50	$2152 \times 10^{-4}$ m <sup>2</sup>
HTR02-85X85	$3692 \times 10^{-4}$ m <sup>2</sup>
Guard width to thickness ratio	
HTR02-50X50	6 m/m
HTR02-85X85	6 m/m
Heater thickness	$0.1 \times 10^{-3}$ m
Heater thermal resistance	$4 \times 10^{-4}$ K/(W/m <sup>2</sup> )
Heater thermal conductivity	0.27 W/(m·K)
Standard cable length	2 m
Cable diameter	$2 \times 10^{-3}$ m
Heater wiring	4 x copper wire, AWG 28, solid core, bundled with PFA sheath
Wire diameter	$1 \times 10^{-3}$ m
Marking	1 x label at the end of HTR02's cable, showing serial number and nominal resistance
IP protection class	IP67
Rated operating relative humidity range	0 to 100 %

**Table 3.1** Specifications of HTR02 series (started on previous page).

Gross weight including 2 m cable	approx. 0.5 kg
Net weight including 2 m cable	approx. 0.5 kg
<b>ELECTRICAL CHARACTERISTICS</b>	
Heater resistance (nominal) per dimension (measured value supplied with each sensor in the production report)	
HTR02-50X50	120 $\Omega \pm 10 \%$
HTR02-85X85	40 $\Omega \pm 10 \%$
Temperature coefficient of resistance	< 0.02 %/°C
Heater rated power supply	24 VDC
Heater power supply	12 VDC (nominal)
Power consumption at 12 VDC per dimension	
HTR02-50X50	1.20 W
HTR02-85X85	3.60 W
Nominal heat flux at 12 VDC per dimension	
HTR02-50X50	500 W/m <sup>2</sup>
HTR02-85X85	500 W/m <sup>2</sup>
<b>INSTALLATION AND USE</b>	
Installation	see the recommendations in this user manual
Cable and wire extension	see the chapter on cable extension or order heaters with longer cables

### 3.2 Dimensions of HTR02 series

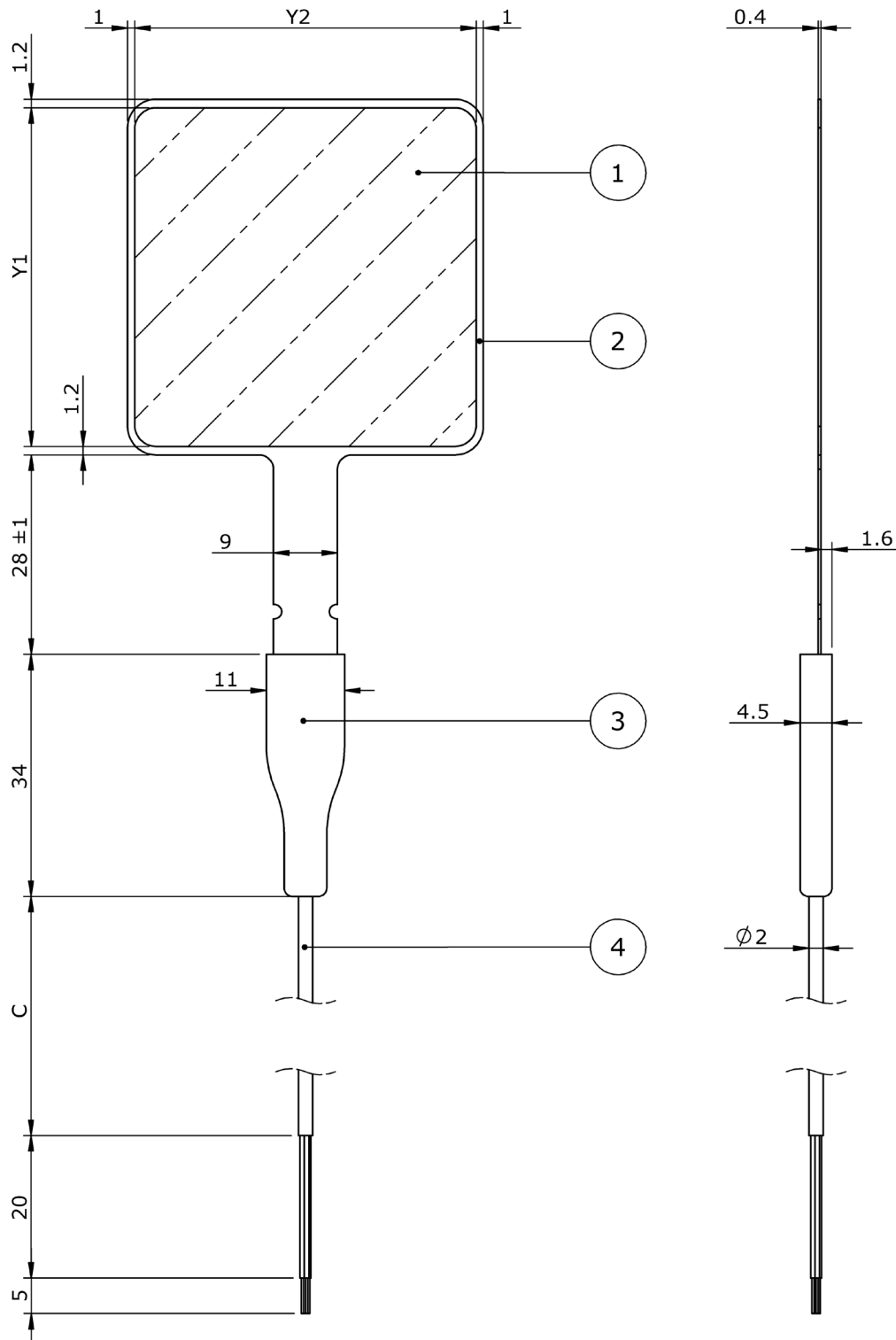

**Figure 3.2.1** Models HTR02 -50X50 and -85X85; Y1 = 47.6 or 82.6 and Y2=48 or 83, dimensions in  $\times 10^{-3}$  m.

- (1) heater area
- (2) passive guard
- (3) cable connection block for strain relief
- (4) cable, standard length C = 2 m

## 4 Installation of HTR02 series

### 4.1 Site selection and installation

**Table 4.1.1** Recommendations for installation of HTR02 series.

Surface cleaning and levelling	create a clean and smooth surface of at least the same outer dimensions as the heater: (50 x 50) or (85 x 85) x 10 <sup>-3</sup> m
Mounting: avoiding strain on the heater-to-cable transition	the heater-to-cable transition is vulnerable during installation as well as operation, the user should provide proper strain relief of the cable so that the transition is not exposed to significant force first, install the cable including strain relief and after that install the heater
Mounting: using a guard	in case the sensor is smaller than the HTR02 heater, a guard is recommended. We suggest making a guard of a material with equal thermal resistance and thickness for best measurement results. See section 2.3.
Mounting: curved surfaces	when mounting HTR02 on curved surfaces, observe the rated bending radius
Mounting: combination with heat flux sensor	when mounting the HTR02 in combination with a heat flux sensor such as the FHF05, keep the directional sensitivity of the heat flux sensor and the position of the heater in mind
Short term installation	avoid any air gaps between the heater and the surface. Air thermal conductivity is in the 0.02 W/(m·K) range, while a common glue has a thermal conductivity around 0.2 W/(m·K). A 0.1 x 10 <sup>-3</sup> m air gap increases the effective thermal resistance of the sensor by 200 % to avoid air gaps, we recommend thermal paste or glycerol for short-term installation  use tape to mount the connection block of the heater  usually, the cables are provided with an additional strain relief, for example using a cable tie mount as in Figure 4.1.1
Permanent installation	for long-term installation, fill up the space between heater and object with silicone construction sealant, silicone glue or silicone adhesive, that can be bought in construction depots.  we discourage the use of thermal paste for permanent installation because it tends to dry out. Silicone glue is more stable and reliable

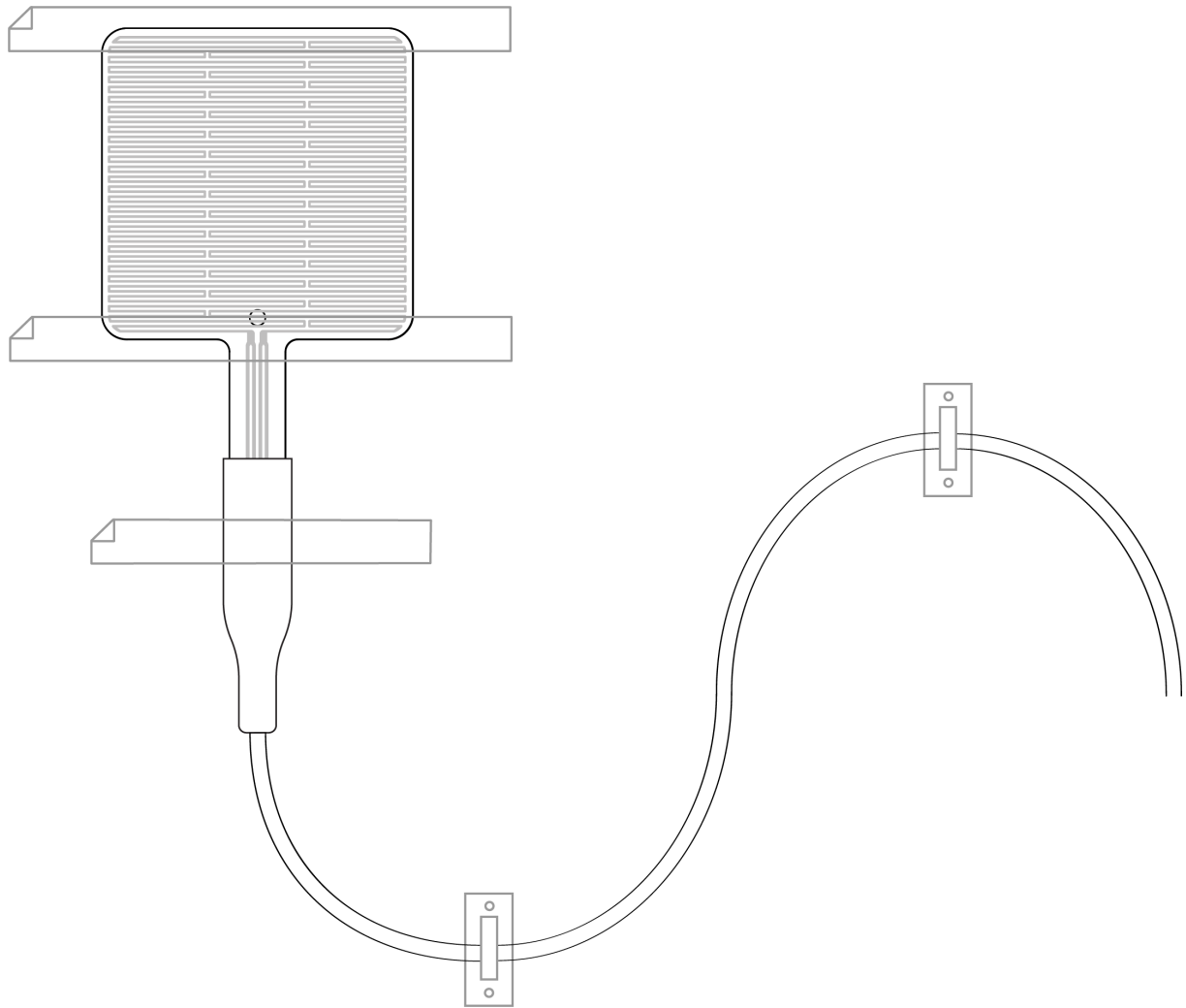

**Figure 4.1.1** *Installation of model HTR02-50X50 using tape to fixate the sensor and the connection block. Extra strain relief of the cable is provided using cable tie mounts equipped with double-sided tape as an adhesive. As indicated in Table 4.1.1, tapes fixating the sensor are preferably taped over the passive guard area. In this case, a third tape (in the middle) is added for extra support.*

## 4.2 Electrical connection

### 4.2.1 Electrical diagram

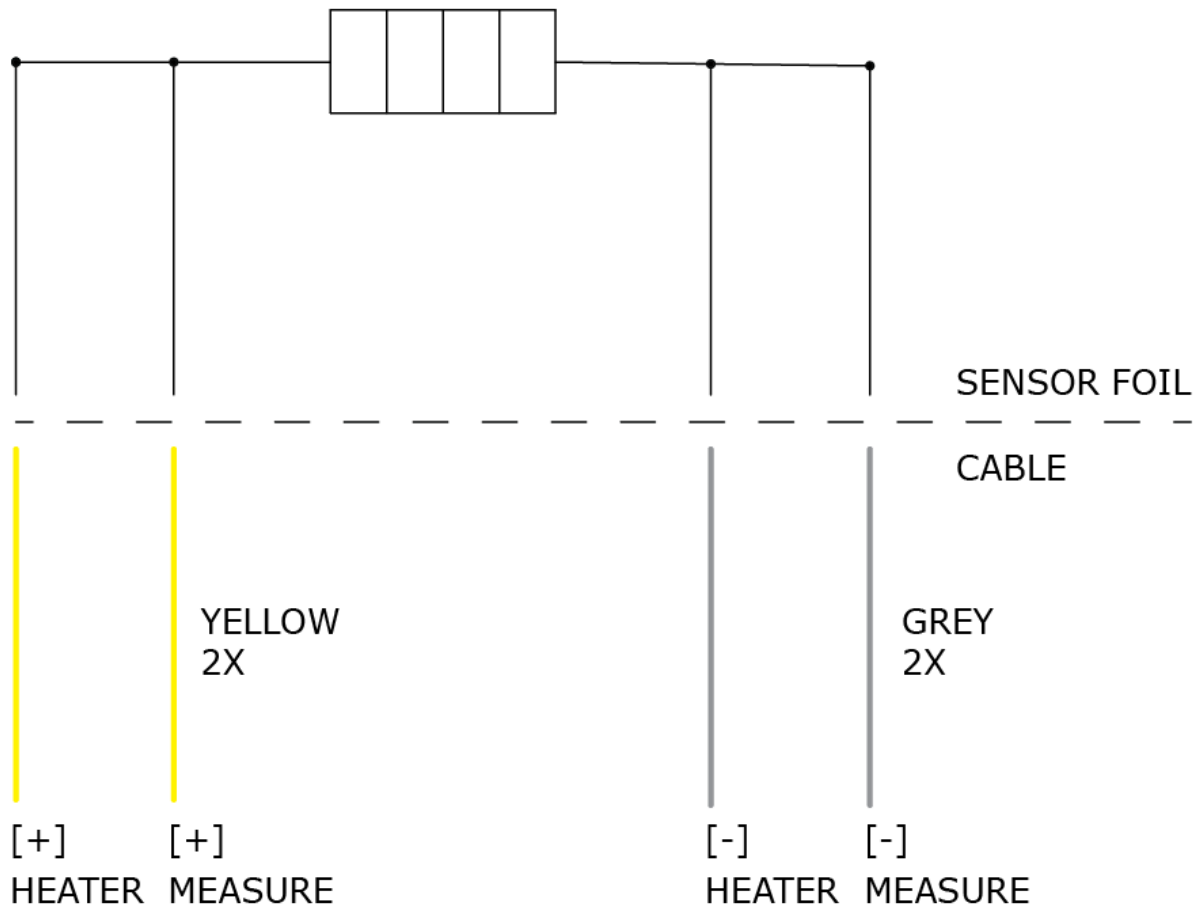

**Figure 4.2.1.1** *Electrical diagram of heater foil of the HTR02 series.*

### 4.2.2 Normal connection

To apply a heat flux, HTR02 should be connected to a power supply. If a variable heat flux is required, the heater is preferably connected to a programmable DC power supply (see Figure 4.2.1.1). The HTR02 electrical connections are explained in Table 4.2.1. When connecting HTR02, always observe the rated heater voltage. Users must make sure that the used power supply is able to source sufficient current.

**Table 4.2.2.1** The electrical connections of HTR02. The heater has a cable consisting of four wires. The two yellow wires are equivalent, and the two grey wires are equivalent. Together they serve to make a 4-wire connection to the heater.

WIRE	HEATER
Yellow	heater power [+]
Yellow	heater measure [+]
Grey	heater power [-]
Grey	heater measure [-]

 <b>CAUTION</b>
<p><b>Do not put a voltage of more than 0.1 V over 2 wires that connect to the same side of the heater: the two yellow wires on one side of the heater, or the two grey wires on the other side of the heater.</b></p> <p><b>The traces on the heater foil may overheat and get damaged beyond repair.</b></p>

<b>NOTICE</b>
<p><b>Putting more than 24 Volt across the sensor wiring can lead to permanent damage to the heater.</b></p>

The heat generated by HTR02 can be accurately determined by measuring the heater voltage and current in a four-point measurement. To this end, HTR02 has a four-wire connection: two yellow wires and two grey wires. A voltmeter should be used to measure the voltage between one of the yellow and one of the grey leads (heater measure [+] and [-] in Figure 4.2.1.1). Working either with formula 2.2.1 or 2.2.2, either

- an ammeter should be used to measure the current through the other yellow and grey leads (heater [+] and heater [-] in Figure 4.2.1.1), using I and V to estimate the heater power, or
- a voltage lower than 24 VDC should be applied to the other yellow and grey leads (heater [+] and heater [-] in Figure 4.2.1.1), using V and R to estimate the heater power

Suggested HTR02 connections are shown in Figure 4.2.1. The heater serial number and electrical resistance R are shown on the HTR02 product certificate and on the label at the end of the cable.

When extending the HTR02 cable, please consider the thickness and electrical resistance of the wires: too thin wires may lead to excessive heating of the wires themselves.

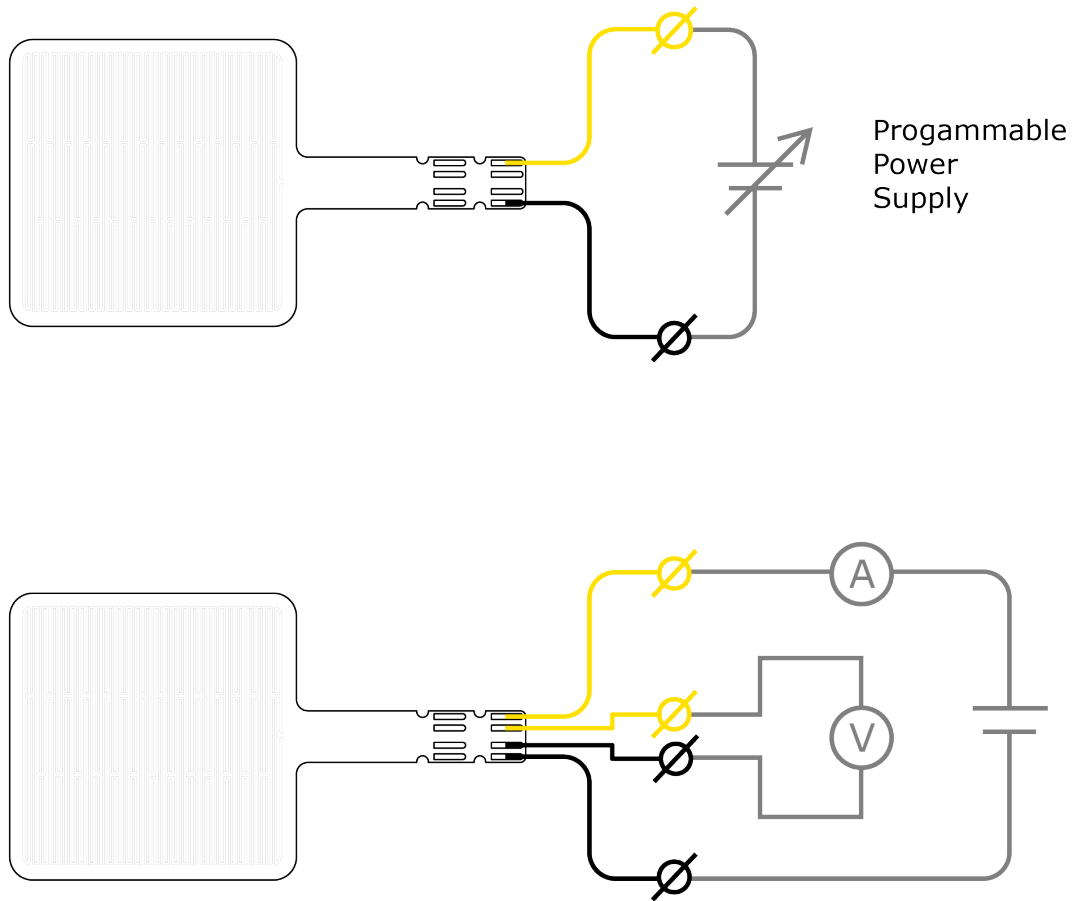

**Figure 4.2.2.1** Suggested HTR02 heater wiring. Two heater wires are used to carry the heater current; the two others are used to measure the voltage over the heater. There is no significant current flowing through voltage measurement wires, so there is no voltage drop over these wires. This "4-wire connection" measures the true voltage over the heater.



### 4.3 Requirements for data acquisition and control

The selection and programming of the measurement and control system for heaters is the responsibility of the user.

**Table 4.3.1** *Requirements for data acquisition and control equipment for HTR heaters.*

Heater power supply	Typically by a DC power supply with a voltage output in the 12 VDC range. In most cases, 5 W power is sufficient. Preferably with a capability to measure current as well.
Switching heater power	Typically with a solid-state relay
Measuring heater voltage and current	There are several possibilities to measure heater power. Depending on the method users may measure voltage, current or both When measuring the power supply voltage: typically around 12 VDC, preferably with a 1% or better uncertainty When measuring heater current: typically in the 0.1 to 0.3 A range, preferably with a 1% or better uncertainty

## 5 Maintenance and trouble shooting

### 5.1 Recommended maintenance and quality assurance

The HTR02 series performs reliably at a low maintenance level. Unreliable heater output can be detected by scientific judgement, for example, by looking for unreasonably large or small measured values. The preferred way to ensure a reliable heater output is a regular critical review of the measured data.

**Table 5.1.1** *Recommended maintenance of HTR02 series. If possible, the data analysis is done daily.*

<b>MINIMUM RECOMMENDED HEAT FLUX SENSOR MAINTENANCE</b>			
	INTERVAL	SUBJECT	ACTION
1	1 week	data analysis	compare measured data to the maximum possible or maximum expected heater power, to other measurements from other redundant instruments and to data previously measured under identical circumstances. Look for any patterns and events that deviate from what is normal or expected. Compare to acceptance intervals.
2	6 months	inspection	inspect cable and wire quality, inspect mounting, inspect location of installation look for seasonal patterns in measurement data
3	2 years	lifetime assessment	judge if the instrument will be reliable for another 2 years, or if it should be replaced

## 5.2 Trouble shooting

**Table 5.2.1** *Trouble shooting for HTR02 series.*

---

General	<p>Inspect the heater for any damage. Inspect the quality of mounting / installation. Inspect if the wires are properly attached to the data logger. Check the condition of the cable. Check the data logger program, particularly if the correct resistance is entered when not measuring according to the 4-wire method. The HTR02 resistance and serial number are shown on the product certificate and on the sticker at the end of the cable.</p> <p>Check the electrical resistance of the sensor between all wires. See Table 5.2.2 and Table 5.2.3 for the nominal resistance per wire combination. Actual resistance values may vary with the sensor and with cable length. The typical resistance of the wiring is 0.2 <math>\Omega</math>/m. Infinite resistance indicates a broken circuit; zero or a lower than 1 <math>\Omega</math> resistance indicates a short circuit.</p> <p>Check the heater resistance value in <math>\Omega</math> on the product certificate.</p>
The heater measurements show unexpected variations	<p>Check the presence of strong sources of electromagnetic radiation (radar, radio). Check the condition of the heater cable. Check if the cable is not moving during the measurement. If available on your data logger, turn on 50 Hz or 60 Hz noise filtering. Ground your data logger</p>

---

**Table 5.2.2** *Indicative electrical resistances between wires for HTR02-50X50 with standard cable length.*

	Yellow	Yellow	Grey	Grey
Yellow	x	1 Ω	120 Ω	120 Ω
Yellow		x	120 Ω	120 Ω
Grey			x	1 Ω
Grey				x

**Table 5.2.3** *Indicative electrical resistances between wires for HTR02-85X85 with standard cable length.*

	Yellow	Yellow	Grey	Grey
Yellow	x	1 Ω	40 Ω	40 Ω
Yellow		x	40 Ω	40 Ω
Grey			x	1 Ω
Grey				x

## 6 Appendices

### 6.1 EU declaration of conformity



We,

Hukseflux Thermal Sensors B.V.,  
Delftechpark 31, 2628 XJ, Delft,  
The Netherlands

hereby declare under our sole responsibility that:

Product model	HTR02 series, all models
Product type	heater for calibration and verification of performance of FHF-type heat flux sensors

is in conformity with the following directives:

2011/65/EU, EU 2015/863	The Restriction of Hazardous Substances Directive
-------------------------	---

This conformity is declared using the relevant sections and requirements of the following standards:

Hazardous substances	RoHS 2 and EU 215/863 amendment known as RoHS 3
----------------------	---

A handwritten signature in blue ink, appearing to be 'Eric Hoeksema', written over a light blue grid background.

Eric HOEKSEMA  
Director  
Delft, 15 November 2022

